



Bosch IDS Family of Inverter Heat Pumps

Quick Start Guide



The robust Bosch Inverter Ducted Split Air Source Heat Pump system utilizes just the right amount of energy to achieve ultimate comfort at maximum efficiency while keeping sound levels to a minimum.

- ▶ Designed for easy installation & start-up
- ▶ Support & spare parts readily available
- ▶ Easy to maintain & service

Bosch Inverter Drive Technology Provides Maximum Comfort, Minimum Energy!

Product Brochure

Scan QR to view



Bosch Inverter Ducted Split Family



The Bosch Inverter Ducted Split Family provides supremely-efficient comfort by adjusting compressor capacity rather than a simple on/off control like other units, thereby reducing operating costs and saving you money. With enhanced humidity control and higher efficiency, the performance of the Bosch IDS Family provides you with maximum comfort with minimal energy usage! Our system's intelligent features work in tandem with your thermostat to automatically adjust to your preferences, while integrated sound dampening features keep the equipment quiet for your peace of mind.

15 SEER System IDS Light



- ▶ The first 15-SEER Inverter condenser on the market.
- ▶ With IDS Light, you get the comfort of our inverter system at a price point you'll love!
- ▶ This system combines the standard efficiency BOVA15 outdoor unit with our BVA15 fixed-speed air handler.

18 SEER System IDS Plus



- ▶ Our most popular system, the IDS Plus, provides the perfect balance of efficiency and comfort, without breaking the bank.
- ▶ This system combines the efficient and reliable BOVB18 outdoor unit with our exceptional BVA20 two stage constant torque ECM style air handler.

20 SEER System IDS Premium



- ▶ Qualify for maximum energy rebates and save the most on energy costs with our highest efficiency offering: IDS Premium.[§]
- ▶ This system combines our top tier BOVA20 outdoor unit with our exceptional BVA20 two stage constant torque ECM style air handler.

20 SEER System IDS Premium Connected⁽¹⁾⁽²⁾



- ▶ Provides the same premium 20-plus SEER energy efficiency.
- ▶ Features wireless connectivity.
- ▶ The Bosch EasyAir app enables in-app product registration, simplifies installation and troubleshooting, and allows remote monitoring of energy usage as well as critical alerts.

¹ Visit www.bosch-homecomfort.us to find the available efficiency rebates in your area. [§] Please go to www.bosch-homecomfort.us for full limited warranty details *Product sold separately
(1) The connectivity features are only available in the U.S. (2) These features are offered for 2 years. Afterwards, certain fees may apply.

Bosch Has Developed and Built The Perfect HVAC System For Your Home

Bosch IDS systems utilize just the right amount of energy to achieve ultimate comfort year after year, all while keeping sound levels to a minimum. Choose the Bosch IDS system that is right for you and enjoy our peace of mind 10 Year Bosch warranty![§]

Installer Friendly

- ▶ Designed for easy installation
- ▶ Intuitive controls
- ▶ Support readily available
- ▶ Spare parts readily available
- ▶ Easy to maintain and service
- ▶ On-board diagnostics
- ▶ In-app guides to assist installation⁽³⁾



Bosch IDS Family

- ▶ IDS Light up to 16.0 SEER | 9 HSPF
- ▶ IDS Plus up to 18.5 SEER | 9.5 HSPF
- ▶ IDS Premium up to 20.5 SEER | 10.5 HSPF
- ▶ IDS Premium Connected up to 20.5 SEER | 10.5 HSPF
- ▶ Fully-modulating inverter drive
- ▶ Sound levels as low as 56 dBA⁽¹⁾
- ▶ 8 Air handlers – 2, 3, 4, 5 Ton
- ▶ 9 Condensing units – 2, 3, 5 Ton
- ▶ Compatible with most 24 VAC thermostats
- ▶ Bosch engineering & quality
- ▶ Designed and tested to Bosch standards
- ▶ 10-year residential limited warranty[§]

IDS Portfolio Pairing

Refer to this chart below for full portfolio combination availability. In addition to the IDS Light, Plus, and Premium, we also offer other matches to maximize system flexibility.

IDS PORTFOLIO PAIRING		OUTDOOR UNIT		
		IDS LIGHT (BOVA15)	IDS PLUS (BOVB18)	PREMIUM / PREMIUM CONNECTED (BOV*20)
Indoor unit	BVA15	✓	✓	-
	BVA20	✓	✓	✓
	Cased Coil Only	-	✓	✓
	BGH96 + Cased Coil	✓	✓	✓

(1) 56 dBA sound level is based on outdoor unit. § Please go to www.bosch-homecomfort.us for full limited warranty details (3) only available with IDS Premium Connected

Choose the System That's Right For You

Quality engineering, quiet performance and an unbeatable warranty from Bosch delivers exceptional home comfort. Whether heating or cooling, our reliable inverter heat pumps keep homeowners comfortable by providing precise indoor temperature and humidity control. These high-efficiency, robust and quiet Inverter Ducted Split system heat pumps are available in four sizes ranging from 2 to 5 ton capacity to suit your needs. This system boasts a inverter drive which adjusts the speed of the compressor to optimize comfort, while keeping sound levels to a minimum and utilizing the right amount of energy to achieve maximum comfort.



IDS Family Components Features & Benefits

What is Inverter
Technology?

Scan to Watch Video

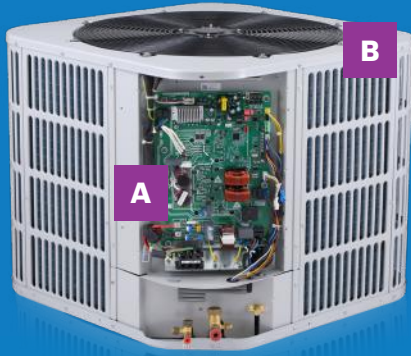

Bosch BOVA15
Outdoor Inverter Condenser

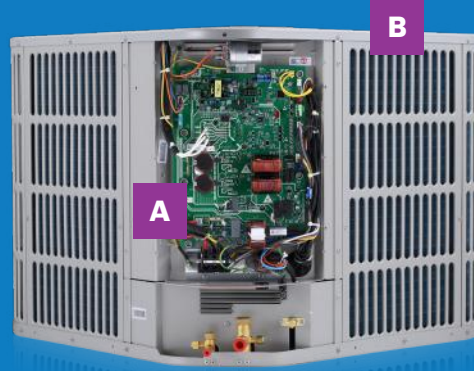

Bosch BOVB18
Outdoor Inverter Condenser

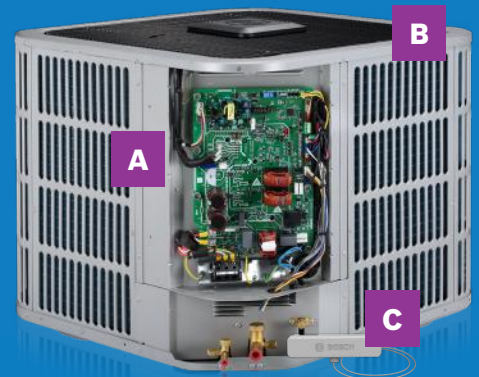

Bosch BOVA20 / BOVB20
High-Efficiency Outdoor Inverter Condenser

A Intelligent control features help adjust the output capacity, allowing the unit to keep the temperature at your desired level without fluctuation and to keep humidity in check during the summer months. Whether it be summer or winter, the system keeps your home comfortable and the living conditions to your desired taste. The BOVA15 condenser has a smaller unit footprint than the BOVB18 and BOVA*20 and also includes an ECM Motor for all capacities (2,3, and 5 ton).

- ▶ The air coil design provides exceptional heat transfer and low air-resistance for high-efficiency operation that can help lower your energy costs.
- ▶ The direct-drive fan blades provide vortex suppression to reduce sound of airflow exiting the condensing section, thereby retaining low noise at high speed - with sound levels as low as 56 dBA for BOVB18, 59 dBA for BOVA15.
- ▶ The condensing units come standard with an electronic expansion valve (EEV) to ensure proper refrigerant flow during all conditions. This helps optimize the unit's operation to the highest efficiency possible.

B The high-efficiency variable capacity inverter compressor in the condensers can adjust to speeds ranging from 26% to 130% to perfectly cool and heat your home using minimal energy for maximum comfort.

- ▶ BOVA15 can adjust to any speed between 33% and 110% (in 1% increments).
- ▶ BOVB18 can adjust to any speed between 26% and 110% (in 1% increments).
- ▶ BOV*20 can adjust to any speed between 36% and 130%. (in 1% increments).

C Featuring wireless connectivity as well as in-app warranty registration, installation, and troubleshooting, the IDS Premium Connected provides an interactive Internet of Things (IoT) platform for contractors and homeowners.

Built on the foundation of the IDS Premium 20 SEER outdoor unit, the IDS Premium Connected enables connectivity features while offering the same performance and comfort as the existing model.

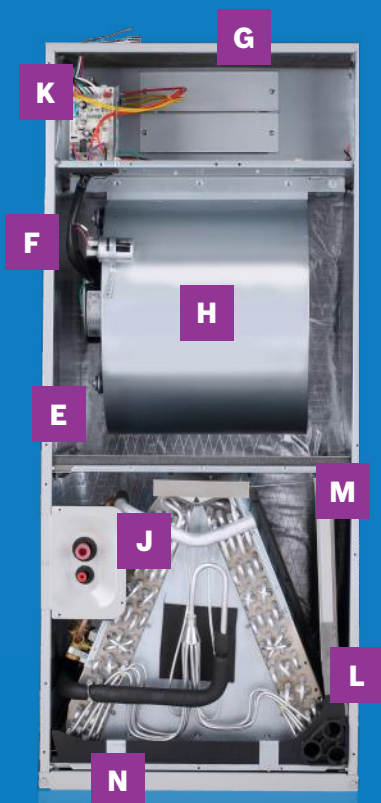

Bosch BVA15

Robust & Reliable Indoor Air Handler

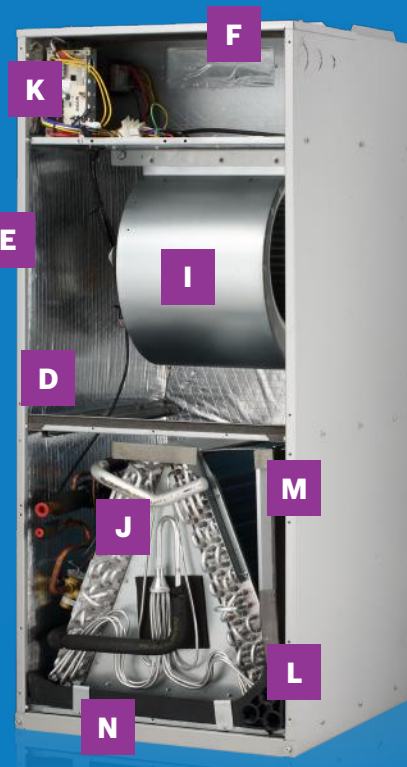

Bosch BVA20

High-Efficiency & Reliable Indoor Air Handler

- E** Material – Foil-faced insulation material on the inner walls decreases energy loss and reduces condensation.
- F** Cabinets – Painted galvanized steel cabinet is salt spray tested for improved durability and corrosion-resistance.
- G** Electric Heat – Can accommodate electric heat with no modification to the cabinet for additional heat on-demand when you need it most.
- H** PSC style motor in the Bosch BVA15 – simple and cost-effective solution.
- I** Two-stage ECM motor in the Bosch BVA20 – Indoor blower stages up and down to provide enhanced comfort, energy savings, and superior humidity control.
- J** All-Aluminum Coil – With excellent heat transfer, efficiency, and humidity removal, the A-coil is more durable and has a lower chance of refrigerant leakage compared to typical copper coils.
- K** Control Board Pocket – A dedicated slot for the control board protects it from humidity in the airstream and extends its lifetime.
- L** Integrated Drain Pan – Made from corrosion-resistant composite material, gently sloped to reduce standing water.
- M** Drain Pan – Flexibility for VT or HZ applications.
- N** Filter Rack – Factory reserved, provides convenience for field installation and serviceability.



Before Everything, There's Bosch.

Bosch Offers Reliable Energy Efficient HVAC Products, That are Simple to Install and Support Readily Available!



Bosch IDS Dual Fuel Provides Optimal Comfort Every Season!

The Ideal Solution For Maximize Comfort & Efficiency

Bosch offers a complete dual fuel heating and cooling system for your home. Dual fuel systems are the ideal solution to maximize comfort and efficiency. In the summer, the Bosch IDS efficiently cools and dehumidifies your home. In the shoulder seasons, the IDS system will provide the exact amount of heating or cooling that your home requires -- no more, no less. In the colder months, the system senses when it is more economical for the heat pump to shut off and the Bosch BGH96 gas furnace to take over. Installing a Bosch matched dual fuel system is the best choice to optimize both savings and comfort.



Outdoor Unit BOVA20



BMAC Cased Coil



BGH96 Furnace

BGH96
Product
Brochure



Scan or Click QR



The Complete & Highly Efficient Dual Fuel Heating and Cooling System For Your Home



A BOVA15, BOVB18, or BOV*20 Outdoor Unit*

The robust Bosch Inverter Ducted Split Air Source Heat Pump system utilizes just the right amount of energy to achieve ultimate comfort and maximum efficiency while keeping sound levels to a minimum. Choose between the BOVA15, BOVB18, or BOV*20 for maximum efficiency.



C Bosch BGH96 96% Furnace*

The BGH96 Gas Furnace offers up to 96% efficiency, a two-stage gas valve, and a multi-speed blower. This ENERGY STAR rated furnace offers premium comfort and energy savings, it is the perfect solution to efficiently heat your home.



B Bosch BMAC Cased Coil*

The Inverter Ducted Split Cased Coil, when paired with a Bosch Furnace and IDS outdoor condensing section, delivers some of the best comfort levels and efficiency on the market today. Bosch offers a complete range of cased coils to fit your needs.



D Bosch BCC100 Wi-fi Thermostat*

The BCC100 is a sleek, internet-connected thermostat that offers easy all-in-one control for your heating and cooling systems. It can be controlled using the Bosch Connected Control app and is compatible with most 24VAC HVAC equipment on the market.

* Products sold separately

Line Sets and Charging

The Bosch BOVA15, BOVB18, OR BOV*20 condensers come factory pre-charged (410a) for 15' of standard size line set. For the BOV*20, up to 150' of line set is allowed with a maximum of 25' lift (refer to Figure 2.1). For the BOVA15 and BOVB18, up to 100' of line set is allowed with a maximum of 50' lift (refer to figure 2.2). Any Application with line set length of more than 15' would require an additional 0.6 oz/ft for each additional foot of line set (refer to Figure 2.2), this can be done by one of two methods: (1) Charge by Weight, (2) Charge by Subcooling.



Figure 2.1

System Capacity Model	Liquid Line	Suction Line	BOV*20 Total Equivalent Length-Feet						BOVA15 & BOVA18 Total Equivalent Length-Feet			
			25	50	75	100	125	150	25	50	75	100
			Maximum Vertical Separation - Feet						Maximum Vertical Separation - Feet			
2 Ton	3/8 *	3/4 Std.	25	50	45	40	30	25	25	50	45	40
		5/8 Opt.	25	50	45	40	30	25	25	50	45	40
3 Ton	3/8 *	3/4 Std.	25	50	50	50	35	25	25	50	50	50
		5/8 Opt.	25	50	50	50	35	25	25	50	50	50
4 Ton	3/8 *	7/8 Std.	25	50	50	40	30	25	25	50	50	40
		3/4 Opt.	25	50	50	40	30	25	25	50	50	40
		7/8 Std.	25	50	50	40	30	25	25	50	50	40
5 Ton	3/8 *	3/4 Opt.	25	50	50	40	30	25	25	50	50	40
		1 1/8 Opt.	25	40	N/A	N/A	N/A	N/A	25	40	N/A	N/A

Figure 2.2

- Total Line Length (ft) = _____ (a)
- Standard Lineset (ft) = 15 (b)
- (a) minus (b) = _____ (c)
- Refrigerant Multiplier = 0.6 oz/ft (d)
- Refrigerant Adder (c*d) = _____ (e)*

*If lineset is less than 15 ft, (e) = 0

*Standard line size is recommended, N/A: Application not recommended

(1) Charge by Weight

Can be used at any time and is the recommended way to charge an IDS system (especially for initial installs). This method can be used when power is not available to the equipment site or when operating conditions are not in range to verify the charge based on subcooling. It is recommend to verify charge and adjust as necessary by subcooling. (Refer to Figure 2.4 for subcooling and superheat requirements.)

(2) Charge Based on Subcooling (AC Mode)

Outside temperature must be between 55° and 120°F and indoor temperature must be between 70° and 80°F to charge by subcooling. After starting the system in cooling mode, short press “FORCE” button (see Figure 2.3), “┌” symbol Appears, and operate the system for a minimum of 20 minutes. (Refer to Figure 2.4 for subcooling and superheat requirements.)

Figure 2.3

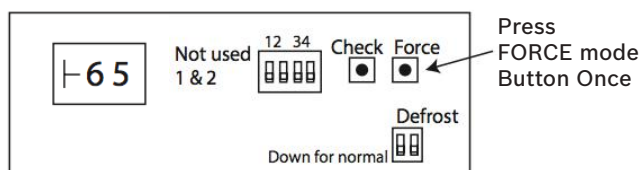

Figure 2.4

Design Subcooling			
Model	Subcooling/°F	Superheat/°F	Note
24K/36K	10±2	10-18	Specification applicable for indoor units with adjustable or non-adjustable TXV
	8±2	7-10	Specification applicable for indoor units with non-adjustable TXV
48K	8±2	9-18	Specification applicable for indoor units with adjustable or non-adjustable TXV
	6±2	7-9	Specification applicable for indoor units with non-adjustable TXV
60K	8±2	8-18	Specification applicable for indoor units with adjustable or non-adjustable TXV
	6±2	6-8	Specification applicable for indoor units with non-adjustable TXV

Design Subcooling		
Model	Subcooling/°F	Superheat/°F
2 Ton	6 - 12	6 - 18
3 Ton	8 - 15	6 - 18
4 Ton & 5 Ton	6 - 12	6 - 18

Figure 2.4 (Continued)

Liquid Temp (°F)	Final Subcooling (°F)							
	6	7	8	9	10	11	12	13
	Liquid Gauge Pressure (PSI)							
55	173	176	179	182	185	188	191	195
60	188	191	195	198	201	204	208	211
65	204	208	211	215	218	221	225	229
70	221	225	229	232	236	239	243	247
75	239	243	247	251	255	259	262	266
80	259	262	266	270	275	279	283	287
85	279	283	287	291	295	300	304	309
90	300	304	309	313	318	322	327	331
95	322	327	331	336	341	346	351	355
100	346	351	355	360	365	370	376	381
105	370	376	381	386	391	397	402	407
110	397	402	407	413	418	424	430	435
115	424	430	435	441	447	453	459	465
120	453	459	465	471	477	483	489	496
125	483	489	469	502	508	515	521	528

Suction Temp (°F)	Final Superheat (°F)								
	6	8	10	12	14	16	18	20	22
	Suction Gauge Pressure (PSI)								
40	105	101	97	93	89	86	82	78	75
42	109	105	101	97	93	89	86	82	78
44	114	109	105	101	97	93	89	86	82
46	118	114	109	105	101	97	93	89	86
48	123	118	114	109	105	101	97	93	89
50	128	123	118	114	109	105	101	97	93
52	133	128	123	118	114	109	105	101	97
54	138	133	128	123	118	114	109	105	101
56	143	138	133	128	123	118	114	109	105
58	148	143	138	133	128	123	118	114	109
60	153	148	143	138	133	128	123	118	114
62	159	153	148	143	138	133	128	123	118
64	164	159	153	148	143	138	133	128	123
66	170	164	159	153	148	143	138	133	128
68	176	170	164	159	153	148	143	138	133
70	182	176	170	164	159	153	148	143	138
72	188	182	176	170	164	159	153	148	143

Control Board & Dip Switch Adjustments

In most scenarios, it is recommended to keep all outdoor unit board dip switch positions in their manufacturer default positions. There are some specific scenarios when it makes sense to change dip switch settings.



Dip Switch SW4

SW4-1 and SW4-2 are not used and should remain in the factory default position at all times. SW4-3 and SW4-4 give you coil temperature and modulation control.

Figure 3.1

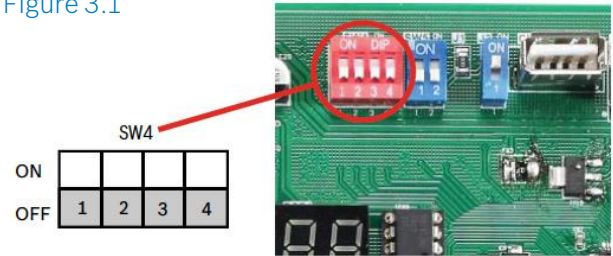

Figure 3.2

Switch		Description
SW4-1	ON	Unused
	OFF*	Must be set at "OFF" position
SW4-2	ON	Unused
	OFF*	Must be set at "OFF" position
SW4-3	ON	Adaptive capacity output disabled
	OFF*	Adaptive capacity output enabled
SW4-4	ON	Accelerated cooling/heating
	OFF*	Normally cooling/heating

SW4-3 Function

Default is OFF position (enabled), allows for coil/condenser target temperature to drift +/- 4°F based on previous hour of operation in an attempt to optimize run time. If dip switch is changed to ON, software requires a "hard" target for coil temperature and does not drift to optimize runtime. **Reason to change from default:** In zoning Applications but only as needed as a result of customer expectations and/or performance.

SW4-4 Function

Default is OFF position, system uses the default target coil temperatures. If dip switch is changed to ON, reduces target coil temperature by 4°F in cooling and increases target coil temperature by 4°F in heating. **Reason to change from default:** Recommended to be used only as-needed as a result of customer expectations and/or performance (i.e. not getting enough capacity, or not dehumidifying well enough).

Dip Switch SW5

Demand Defrost Adjustments

Figure 3.3

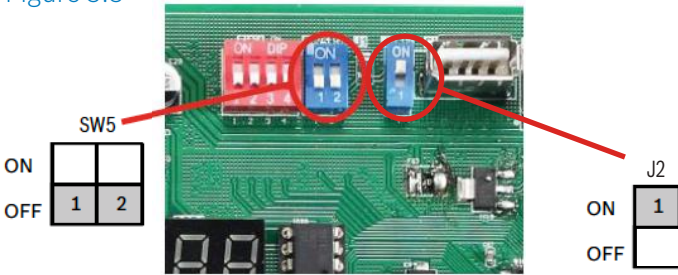

Figure 3.4

Defrosting Choice	SW5-1	SW5-2	Remarks
ON	Operating time is reduced by 10%	Defrosting extended for 60 seconds	
OFF	Normal	Normal	Default
Remarks	Enter defrost	Quit defrost	

SW5-1 Function

Default is OFF position, uses default defrost operating time (maximum of 8 minutes). If dip switch is changed to ON, the default operating time before a unit goes into defrost is reduced by 10%. **Reason to change from default:** Can be used in colder climates to have the unit go into defrost more often.

SW5-2 Function

Default is OFF position, uses default defrost operating time (maximum of 8 minutes). If change dip switch to ON, default defrost time is increased by 1 minute. **Reason to change from default:** Can be used in colder climates, where it make take more time than usual to defrost the outdoor coil.

J2 Function

Default is ON, which leaves the compressor capacity at default (3 or 5 ton depending on the model). Regardless of if the matching air handler is 2 ton or 3 ton (when paired with the 3 ton condenser), or matching air handler is 4 ton or 5 ton (when paired with 5 ton condenser), the J2 jumper can be left at default position. The compressor will ramp to required coil temperature regardless of paired air handler size. **Reason to change from default:** If you want (or need) to minimize maximum condenser capacity from 3 to 2 tons (3 ton condenser model) OR 5 to 4 tons (5 ton condenser model).

Onboard Parameter Check & Diagnostics

1. Press “Check” button to index through parameters.
2. After first pressing on the “Check” button, it will display the sequence, and after 1 second it will display the value of the parameter.
3. After 20 seconds on same parameter, display will revert back to normal status.
4. If a system protection is active, first digit will display “status code.”

Figure 4.1

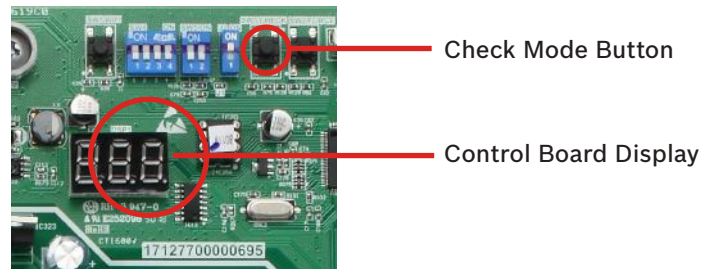

BOVA15 & BOVB18 System parameters Figure 4.2

No.	Point check content
0	Outdoor unit capacity
1	Outdoor unit mode
2	Outdoor unit set compressor speed (Hz)
3	T3 (outdoor coil temp.) (°F)
4	T4 (outdoor ambient temp.) (°F)
5	T5 (compressor discharge temp.) (°F)
6	Reserve
7	BOVA15: T3L (liquid line temp.) (°F) BOVB18: Reserve
8	Tf (module temp.) (°F)
9	Pe (evaporating pressure) (PSI)
10	Pc (condensing pressure) (PSI)
11	Tes target of the evaporating temp. (only use for cooling mode) (°F)
12	Te (evaporating temp.) (°F)
13	Tcs target of the condensing temp. (only use for heating mode) (°F)
14	Tc (condensing temp.) (°F)
15	Target of compressor discharge superheat (only use for heating mode) (°F)
16	Compressor discharge superheat (°F)
17	Openings of EEV
18	Fan speed
19	Compressor current (A)
20	Power AC voltage Input (V)
21	Compressor input dc voltage (V)
22	Continuous running time of the compressor (min)
23	Last fault code
24	Software version
25	Remark“--”

BOV*20 System parameters Figure 4.3

No.	Point check content
0	Outdoor unit capacity
1	Outdoor unit mode
2	Outdoor unit set compressor speed (Hz)
3	T3 (outdoor coil temp.) (°F)
4	T4 (outdoor ambient temp.) (°F)
5	T5 (compressor discharge temp.) (°F)
6	Th (compressor suction temp.) (°F)
7	T3L (liquid line temp.) (°F)
8	Tf (module temp.) (°F)
9	Pe (evaporating pressure) (PSI)
10	Pc (condensing pressure) (PSI)
11	Tes target of the evaporating temp. (only use for cooling mode) (°F)
12	Te (evaporating temp.) (°F)
13	Tcs target of the condensing temp. (only use for heating mode) (°F)
14	Tc (condensing temp.) (°F)
15	Target of the compressor discharge superheat (only use for heating mode) (°F)
16	Compressor discharge superheat (°F)
17	Openings of EEV
18	Fan speed
19	Compressor current (A)
20	Power AC voltage input (V)
21	Compressor input dc voltage (V)
22	Continuous running time of the compressor (min)
23	Last fault code
24	Software version
25	Remark“-”

Manual/Force Defrost

1. System must have a call for heat and have been operating for a minimum of 8 minutes.
2. Press “FORCE” button on inverter board for 6 seconds to begin forced defrost.
3. Wait Approximately 40 seconds for defrost to initiate.
4. Once defrost initiates the display will indicate “dF”.
5. Defrost test will terminate automatically after which the display will indicate running speed.
6. Repeat steps after 5 minutes if second test is required.

Figure 4.4

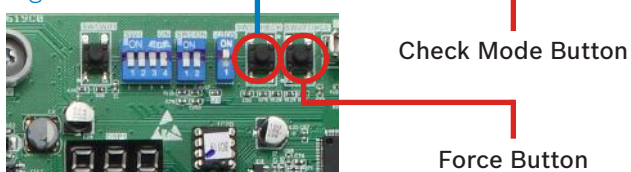

System Protection Codes Figure 4.5

F	Forced operation mode
L	Running indication under T3 limited condition
d	Running indication under T5 limited condition
P	Running indication under compressor ratio limited condition
F	Running indication under TF limited condition
C	Running indication under current limited condition
U	Running indication under low voltage limited condition
A	Running indication under return oil mode
dF	Running indication under defrost mode

BOVA15 & BOV*20 System Fault Codes Figure 4.6

Code	Fault Description (Sensor)
C3	The coil sensor is seated fault in cooling (T3)
E4	Temperature sensor fault (T3, T4, T3L, T5, TF)
E5	High/low voltage protection
E6	DC fan motor fault
E7	Compressor discharge sensor is seated fault (T5)
E9	EEPROM fault
H0	Communication fault in main control chip
H5*	5 times (P2) protection in 100 minutes, system lockout
H8	Pressure transducer fault (PT)
P0	Control board temperature protection (TF)
P1	High pressure switch protection (HPS)
P2	Low pressure protection in cooling or heating (PT)
P3	Compressor over current protection
P4	High compressor discharge temperature protection (T5)
P5	Condensor coil temperature protection in cooling (T3)
P8	DC fan motor hurricane/typhoon protection
PH	Low discharge superheat protection
F1	High pressure switch protection (HPS)
L0-L9	The IPM module protection
ATL	Ambient temperature Limited

*Fault requires hard restart

BOVB18 System Fault Codes Figure 4.7

Code	Fault Description (Sensor)
C3	The coil sensor is seated fault in cooling (T3)
E4	Temperature sensor fault (T3, T4, T5)
E5	High/low voltage protection
E6	DC fan motor fault (only for 48/60K model)
E7	Compressor discharge sensor is seated fault (T5)
E9	EEPROM fault
H0	Communication fault in main control chip
H5*	5 times (P2) protection in 100 minutes, system lockout
H8	Pressure transducer fault (PT)
P0	High module radiator temperature protection (TF)
P1	High pressure switch protection (HPS)
P2	Low pressure protection in cooling or heating (PT)
P3	Compressor over current protection
P4	High compressor discharge temperature protection (T5)
P5	Condensor coil temperature protection in cooling (T3)
P8	DC fan motor hurricane/typhoon protection
PH	Low discharge superheat protection
F1	High pressure switch protection (HPS)
L0-L9	The IPM module protection
ATL	Ambient Temperature Limited

Troubleshooting Made Easy!

The Bosch EasyAir App is your one-stop shop for troubleshooting the IDS Premium Connected. With just a few swipes on your phone, you can easily access information about installation, warranty registration, and how to monitor the unit remotely.



Remote Monitoring & Troubleshooting

Monitor the heat pump's health and visualize real time alerts remotely. View fault codes, live check point values and calculate superheat and subcool values that will help in troubleshooting faults quickly.



Get Notified on System Faults

Receive alerts on your phone right away about unit errors, warnings, and other important updates.



Manage Your Technicians

As the owner of the company or an office admin that dispatches technicians, you can add installers/technicians to your company profile and manage which homeowner units they can access.



Warranty Registration

Quickly and efficiently register products for warranty at the click of a button in the EasyAir App.

Connected Features - Bosch EasyAir Mobile App



The Bosch BOVB20 condenser features wireless connectivity and allows the contractor to access information about warranty registration, installation, and troubleshooting via the Bosch EasyAir App.

To utilize all the connected features of the Bosch BOVB20, ensure the following:

1. The antenna has been mounted as instructed.
2. The Bosch EasyAir App has been downloaded on your smartphone.
3. The BOVB20 condenser has been added to the Bosch EasyAir App.
4. The condenser is linked to the homeowner and access to monitor the condenser remotely has been granted.

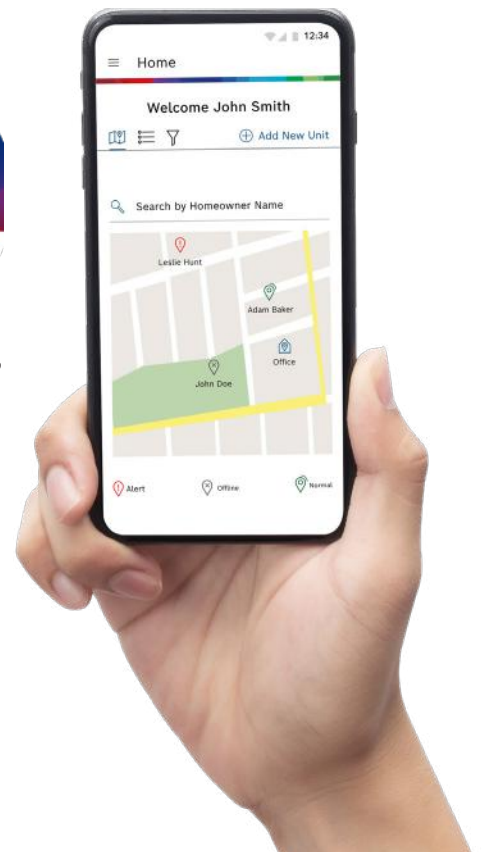

Mounting Antenna

The antenna is used to transmit data to the cloud and will have the strongest signal strength mounted furthest away from a wall or building.

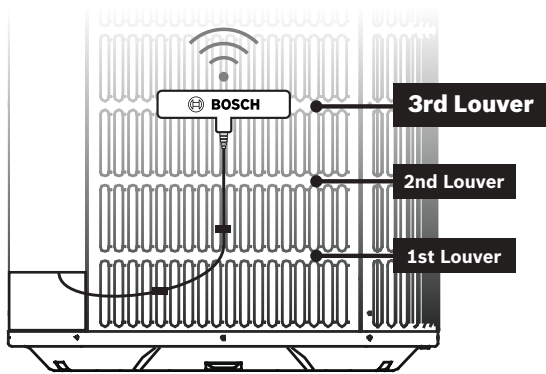

Mount the antenna on the 3rd Louver from the bottom of the unit.

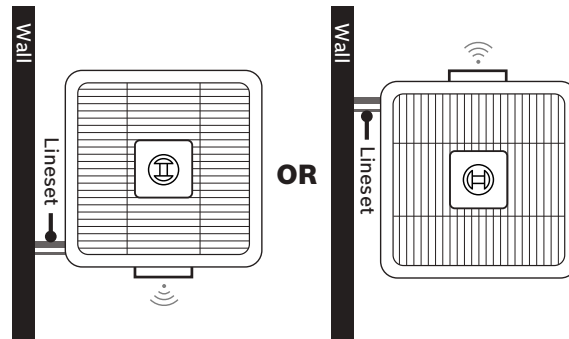

For the strongest signal mount the antenna on the side furthest from a wall on the left or right side of the unit.

Downloading the Bosch EasyAir App

1. Download the Bosch EasyAir App on your smartphone by searching for it in Google Play Store (for Android devices) or App Store (for iPhone). Alternatively, you can scan this QR code with your phone's camera.
2. Open the Bosch EasyAir App and create a profile.

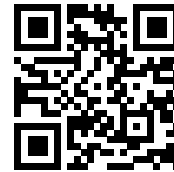

Scan QR with Smartphone to Download App

Adding the Condenser to the Bosch EasyAir App

Open the Bosch EasyAir App, From the 'Home' Screen click on the "Add New Unit" button and follow instructions on the App.

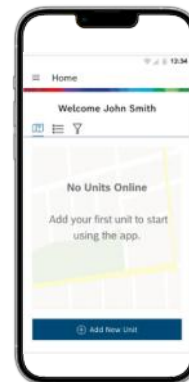

Connecting to the Bosch Premium Connected (BOVB20) Condenser

1. Ensure the unit is powered on.
2. Once the unit is powered on, wait until the gateway has a solid green and amber LED.
3. Launch the Bosch EasyAir App and connect to the unit via Bluetooth.
4. Access the Unit Dashboard to install, troubleshoot and register warranty more efficiently.



Wiring Diagrams

IDS Light with Electric Heat Back-up + BCC100

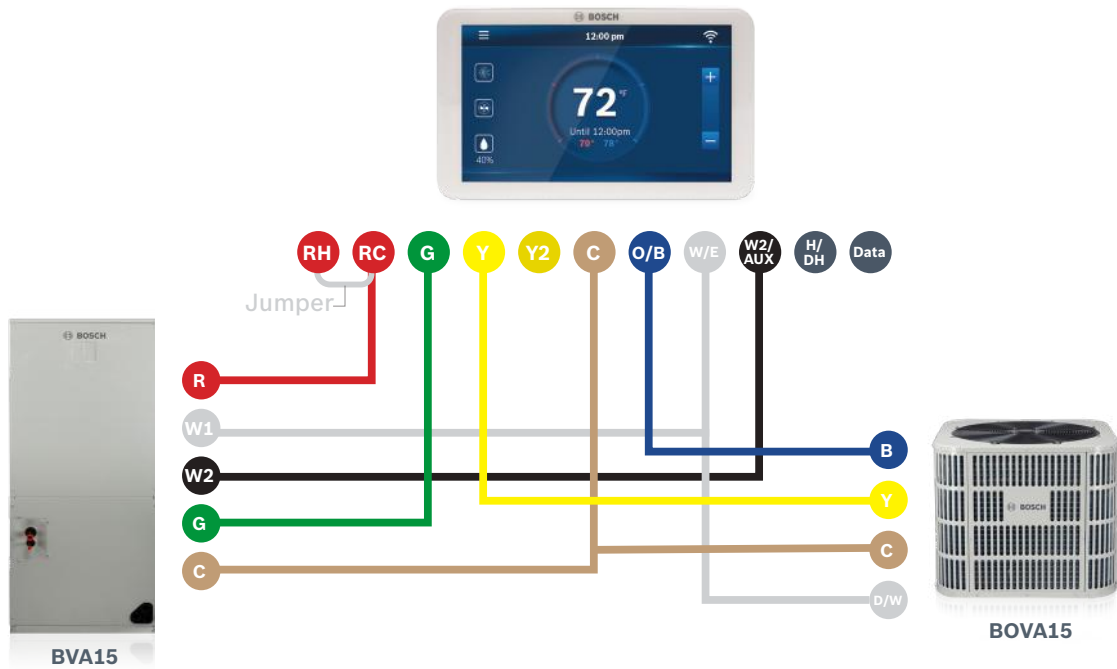

IDS Light with Electric Heat Back-up + BCC50

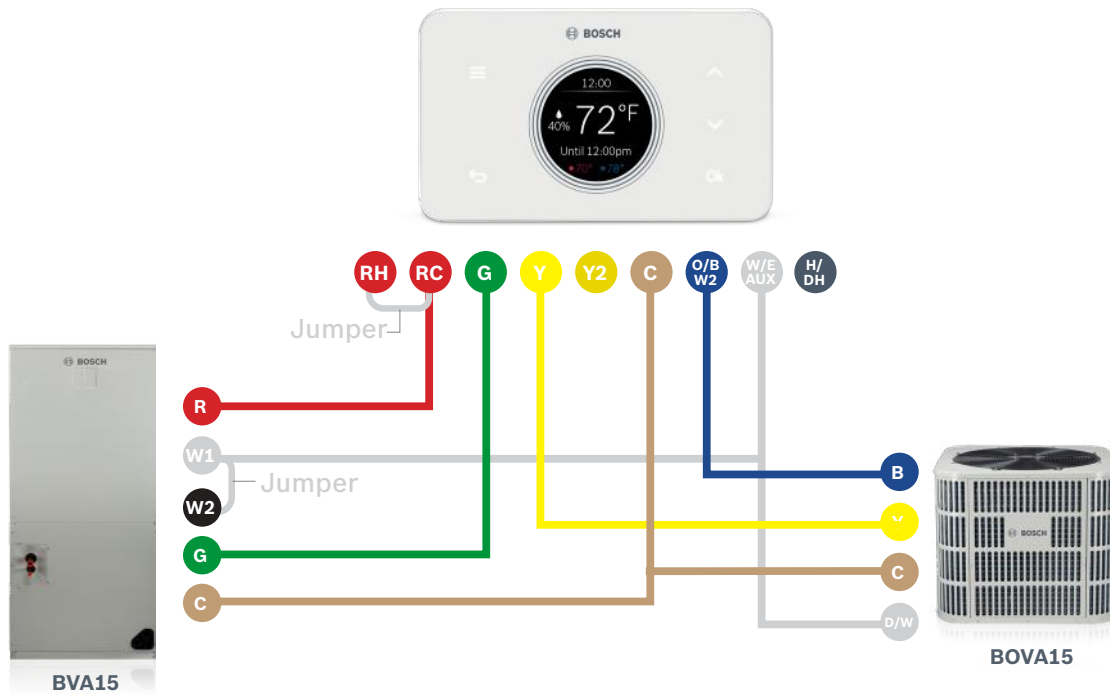

Wiring Diagrams

IDS Plus, IDS Premium, IDS Premium Connected
with Electric Heat Back-up + BCC100

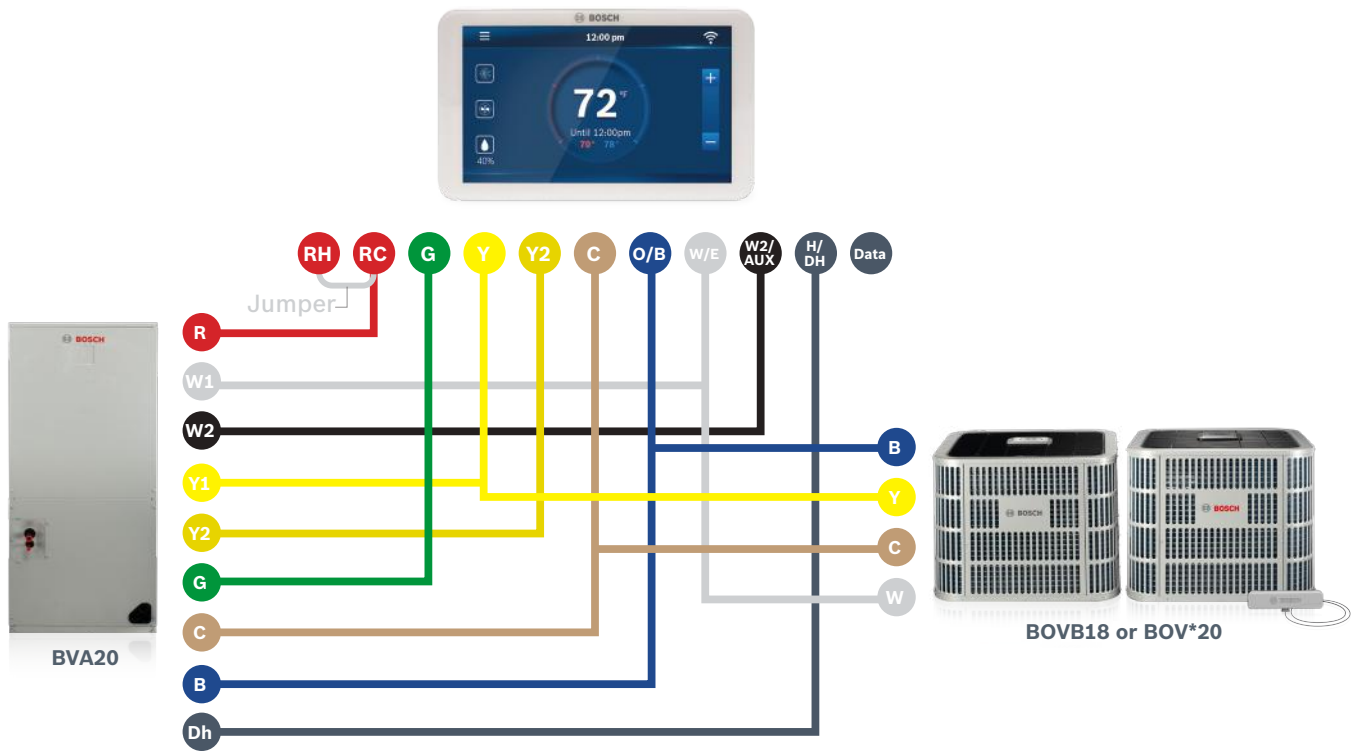

IDS Plus, IDS Premium, IDS Premium Connected
with Electric Heat Back-up + BCC50

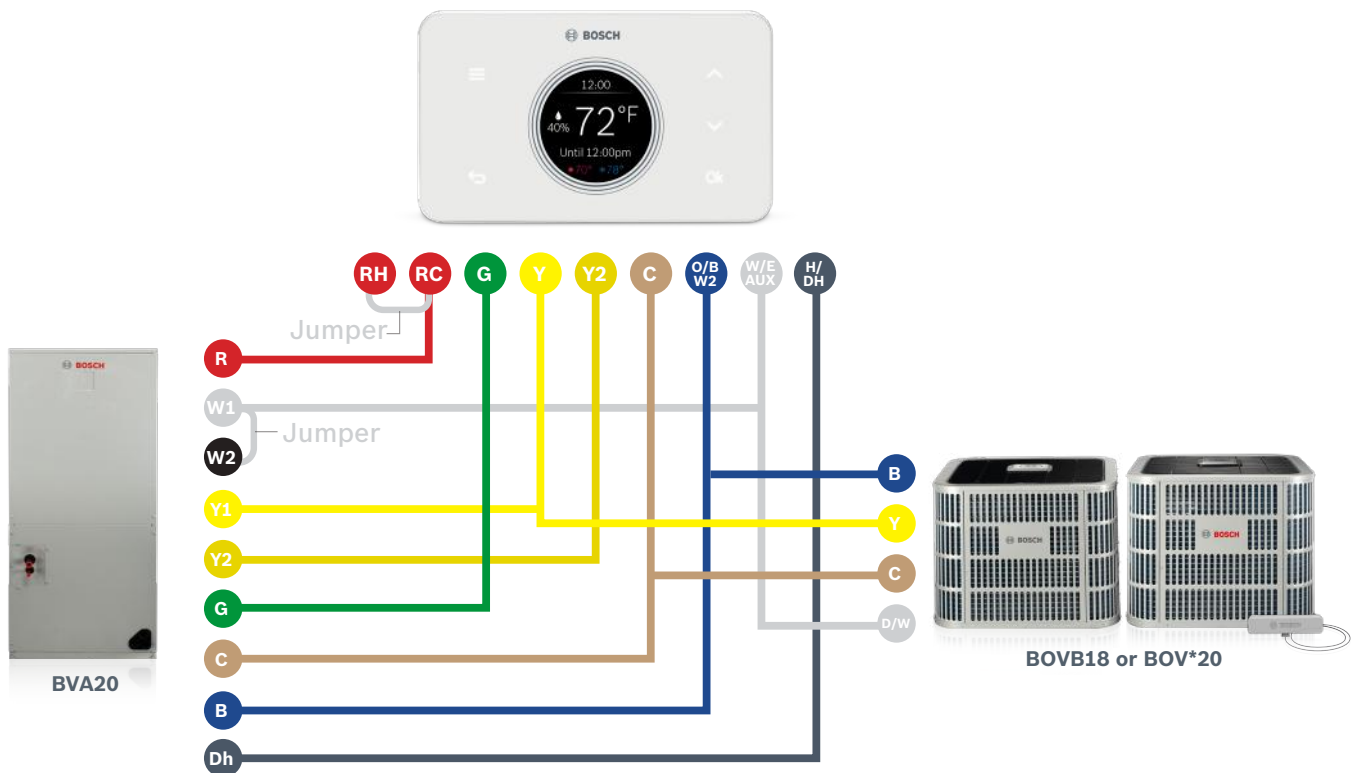

Wiring Diagrams

IDS Light, IDS Plus, IDS Premium & IDS Premium Connected with BGH96 + BCC100

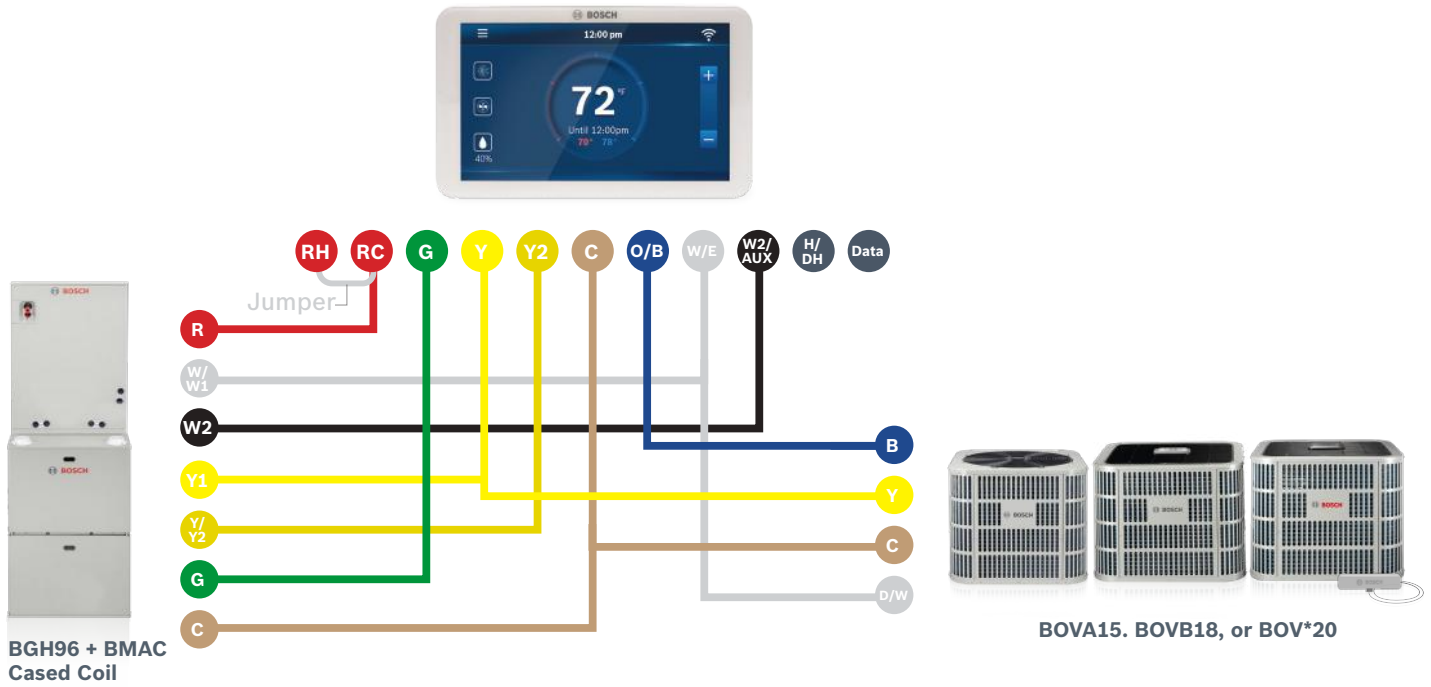

IDS Light, IDS Plus, IDS Premium & IDS Premium Connected with BGH96 + BCC50

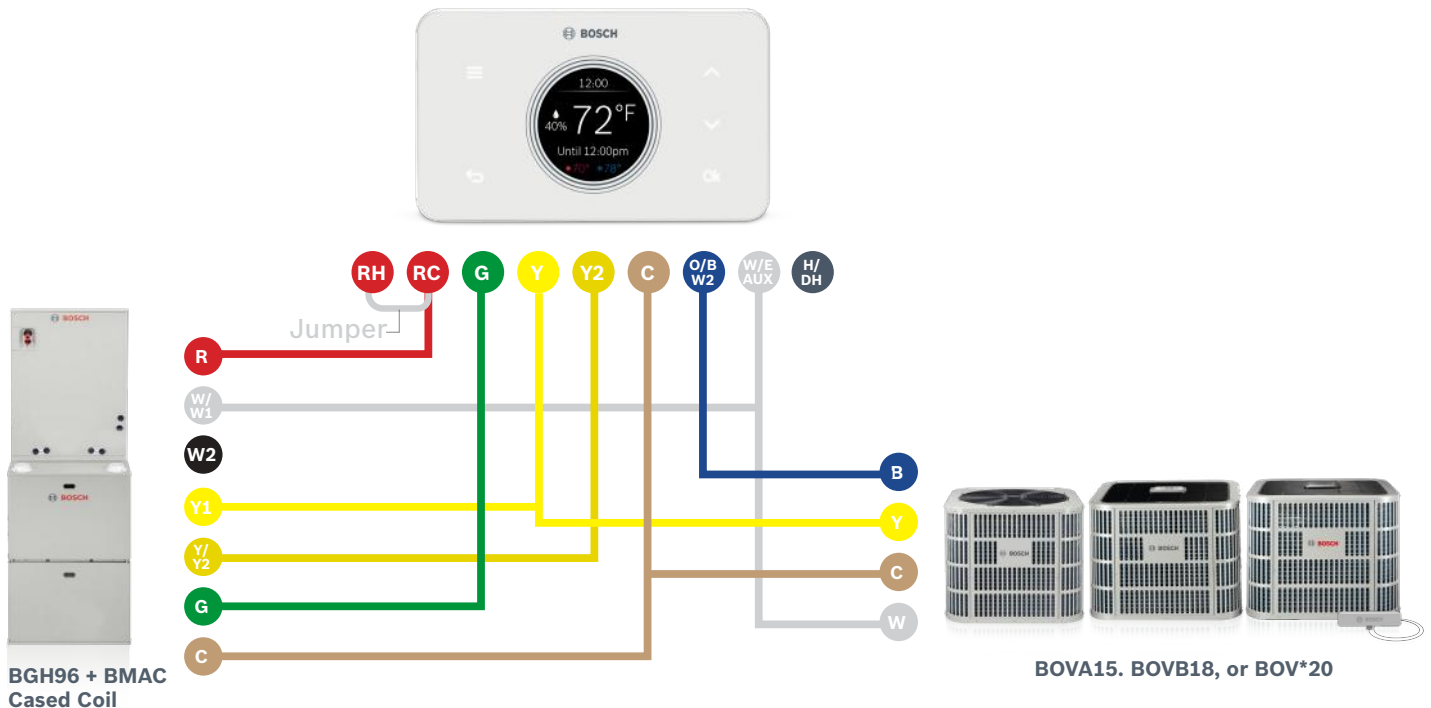



Grow Your Business With Bosch

At Bosch Heating and Cooling, we are committed to supporting our Accredited Bosch Contractors by providing tools to manage and grow your business, allowing you to focus on what matters; providing your customers with comfort they can count on. By choosing Bosch, you represent one of the largest HVAC brands in the market with over 100 years of industry expertise. Join our team of elite dealers to gain access to exclusive sales and marketing tools, technical support, training and more at Bosch-ABCpartner.com.



Accredited Bosch Contractor Benefits

- ▶ Manage your company registrations
- ▶ Access to Bosch current promotions
- ▶ Access to the exclusive ABC Facebook group
- ▶ Access to technical documentation
- ▶ Access to Bosch product brochures
- ▶ Access to the priority support hotline
- ▶ Contact your sales rep (account manager)
- ▶ Points redemption
- ▶ Financing

“The Bosch Accredited Contractor program has truly made a difference in my mind from the customers point of view when we are going up against other companies that are selling the same Bosch or Buderus equipment!”

-Rich's Oil

Apply Online

1. Go to Bosch-ABCpartner.com
2. Click on “Not a user?”
3. Fill out the form
4. You're going to receive an email with a temporary password
5. Update your password and finish your registration filling out the required information

Questions?

Learn more at

Bosch-ABCpartner.com



The Bosch eAcademy

A convenient way to access, view & book training courses



Register For a Bosch Product Training Today

We understand that our contractors are constantly on the go and need a training platform to keep them up to date on the latest technology. On a jobsite, at home or in the office, the Bosch eAcademy platform allows you to take training with you no matter where you go. Create your account today and start learning about the latest HVAC tech that is designed for an easy install, easy service and long lasting durability.

Receive a Bosch Training Certificate in 4 Easy Steps

Step 1: Visit Training.BoschProHVAC.us or **Scan the QR code**

Step 2: Login to your E-Academy account, or select Register if you do not have an account.

Step 3: Once you are registered for E-Academy and are logged in, follow these steps to find your class:

Click Catalog > Select Residential Training > Select Register for Bosch Training > Choose the appropriate category > Find the class you want to register for > Scroll to the bottom of the page to "Schedule" > Select "Details/Register" > Register for the class

Step 4: Once you complete the training, you will receive a certificate of completion.



Before Everything, There's Bosch.

Simple. Reliable. Innovative.

Available Trainings

Class list is updated frequently check eAcademy for the latest classes.

Bosch Furnace

- ▶ BGH96

Bosch Gas Boilers

- ▶ Greenstar
- ▶ Singular
- ▶ GB142/162

Oil Boilers

- ▶ GB125BE

Air Source Heat Pumps

- ▶ IDS Family (Lite, Plus, Premium)
- ▶ Climate 5000 Mini splits
- ▶ IDP Inverter Ducted Packaged Unit
- ▶ Water Source Heat Pumps

Gas Tankless Water Heaters

- ▶ Greentherm T9000 Series



Visit eAcademy

Scan QR with mobile device

70H993104A

Sales, Service & Support

We are here to help!

Customer Support & Tech Support

Tel: 800-283-3787

Operating Hours: Mon-Thur, 8am-6pm, Fri, 8am-5pm EST

Fax: 603-965-7568

Tech Support Fax: 603-965-7581

Customer Service E-mail Address

residential.salessupport@us.bosch.com

Parts Orders or Parts Inquiries:

spareparts.bosch-climate.us

parts.salessupport@us.bosch.com

Technical Support E-mail Addresses

AC: ac.techsupport@us.bosch.com

Furnace: furnace.techsupport@us.bosch.com

Boiler: boiler.techsupport@us.bosch.com

Tankless: tankless.techsupport@us.bosch.com

Warranty & Returns Support E-mail Address

warranty_returns@us.bosch.com

Addresses

65 Grove Street, Watertown, MA 02472

555 NW 65th Court, Fort Lauderdale, FL 33309

50 Wentworth Avenue, Londonderry, NH 03053

Warranty & Return Claim Management

BoschPROHVAC.com

Accredited Bosch Contractor Website

Bosch-ABCpartner.com

Social

Youtube.com/@BoschHomeComfortUS

Facebook.com/BoschHomeComfortUS/

Instagram.com/boschhomecomfort_US/

Customer Support Contact Card

Whenever you need us, we are here for you! Scan the QR code with your mobile device and save our contact card to your contacts.



Scan QR
With Mobile Device



About Bosch

Bosch Home Comfort Group in North America

Bosch Home Comfort Group is a leading source of high quality water heating and comfort systems. The company offers gas tankless, electric whole house and point-of-use water heaters, Bosch and Buderus floor-standing and wall mounted boilers, Bosch and FHP geothermal, water-source and air-source systems as well as controls and accessories for all product lines. Bosch Home Comfort is committed to being Simply Smart by offering products that work together as integrated systems that enhance quality of life in an ultra-efficient and environmentally friendly manner. For more information, visit bosch-homecomfort.us.

Bosch Group

The Bosch Group is a leading global supplier of technology and services in the areas of Automotive, Industrial Technology, Consumer Goods and Building Technology. The company was founded in Stuttgart, Germany, in 1886 and presently has more than 440 subsidiaries and is represented in over 150 countries.

In the U.S., Canada and Mexico, the Bosch Group manufactures and markets automotive original equipment and aftermarket solutions, industrial drives and control technology, power tools, security and communication systems, packaging technology, home comfort solutions, household appliances and software solutions. The Bosch Group's products and services are designed to improving quality of life by providing innovative and beneficial solutions. In this way, the company offers technology worldwide that is Invented for life. Additional information is available online at www.bosch.com



Bosch Home Comfort Group

Watertown, MA | Londonderry, NH | Ft. Lauderdale, FL

General Inquiries: 1-866-642-3198

Copyright © 2023 Bosch Home Comfort Group
All rights reserved. Subject to change without notice.

76HTT3002K 5-23

www.bosch-homecomfort.us